





# ACOOL

ALPHACOOL – THE COOLING COMPANY

## EISBLOCK AURORA - N - 2080 Ti STRIX BACKPLATE

EN	ACCESSORIES	DE	ZUBEHÖR	FR	ACCESSOIRES
					
	2x 8 x 105 x 3 mm Pad	1x 8 x 60 x 3 mm Pad	3x 15 x 60 x 3 mm Pad	1x 30 x 30 x 3 mm Pad	6x M2 x 11 screw

EN Read the safety instructions before starting the installation. ⚠

DE Lesen Sie die Sicherheitshinweise, bevor Sie mit der Installation beginnen. ⚠

FR Lisez les instructions de sécurité avant de commencer l'installation. ⚠



1.

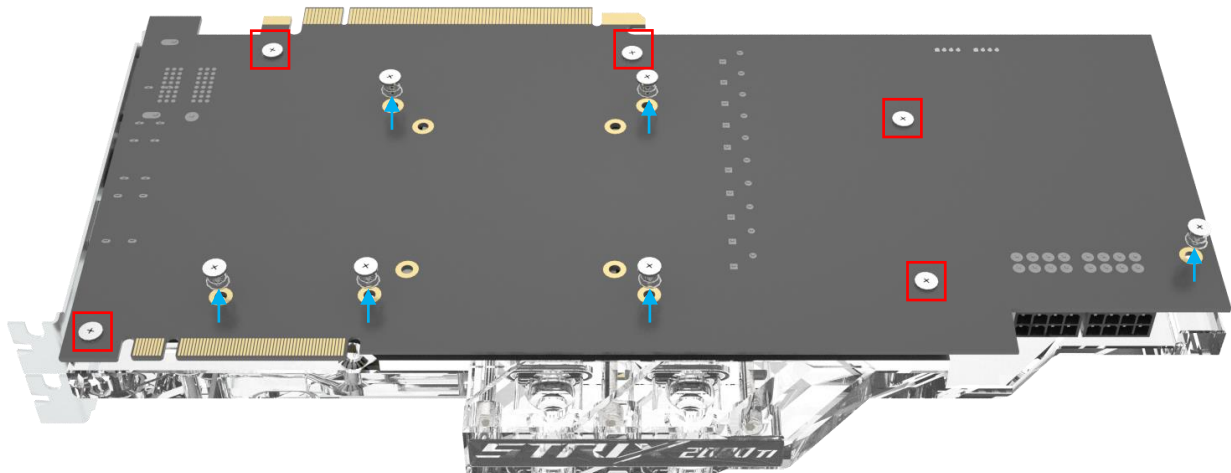

<p>EN If you have already mounted the Eisblock graphic card cooler without backplate according to the instructions, first remove the 6 screws as shown.</p> <p>If you want to use the backplate directly during the initial assembly, follow the Eisblock instructions until step 3 and fix the graphics card only with the 5 highlighted M2x5 screws.</p>	<p>DE Haben Sie den Eisblock Grafikkartenkühler bereits ohne Backplate anleitungsgemäß montiert, entfernen Sie zunächst die 6 Schrauben wie dargestellt.</p> <p>Möchten Sie die Backplate direkt bei der Erstmontage verwenden, folgen Sie die Eisblock Anleitung bis Schritt 3 und fixieren Sie die Grafikkarte lediglich mit den 5 markierten M2x5 Schrauben.</p>	<p>FR Si vous avez déjà monté le refroidisseur de carte graphique sans plaque arrière selon les instructions, retirez d'abord les 6 vis comme indiqué.</p> <p>Si vous souhaitez utiliser la plaque arrière directement lors du montage initial, suivez les instructions du bloc de glace jusqu'à l'étape 3 et fixez la carte graphique uniquement avec les 5 vis M2x5 indiquées.</p>
--	---	--

2.

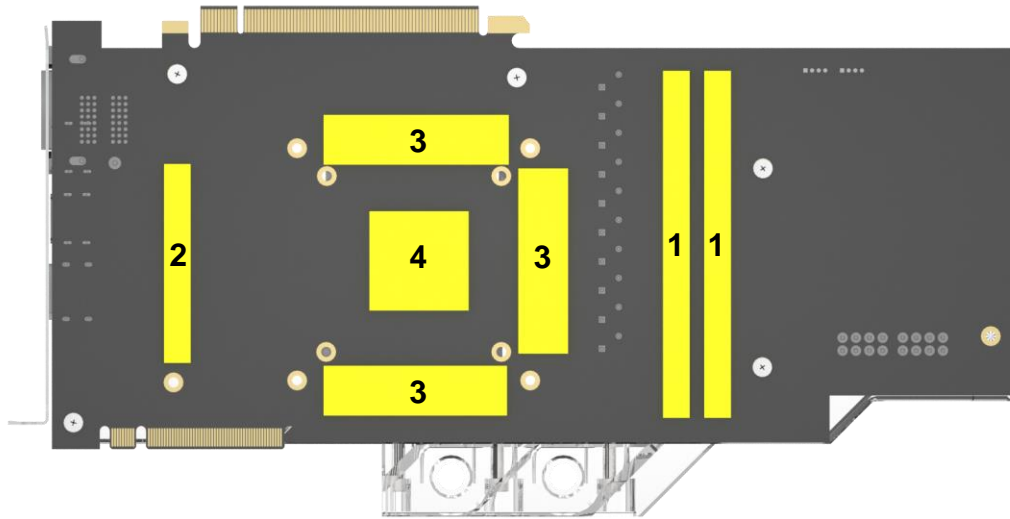

EN

Remove the protective foils from the thermal pads and place the pads on the PCB as shown.

DE

Entfernen Sie die Schutzfolien der Wärmeleitpads und platzieren Sie die Pads wie dargestellt auf der Platine.

FR

Retirez les feuilles de protection des pads thermiques et placez les pads sur la carte comme indiqué.

3.

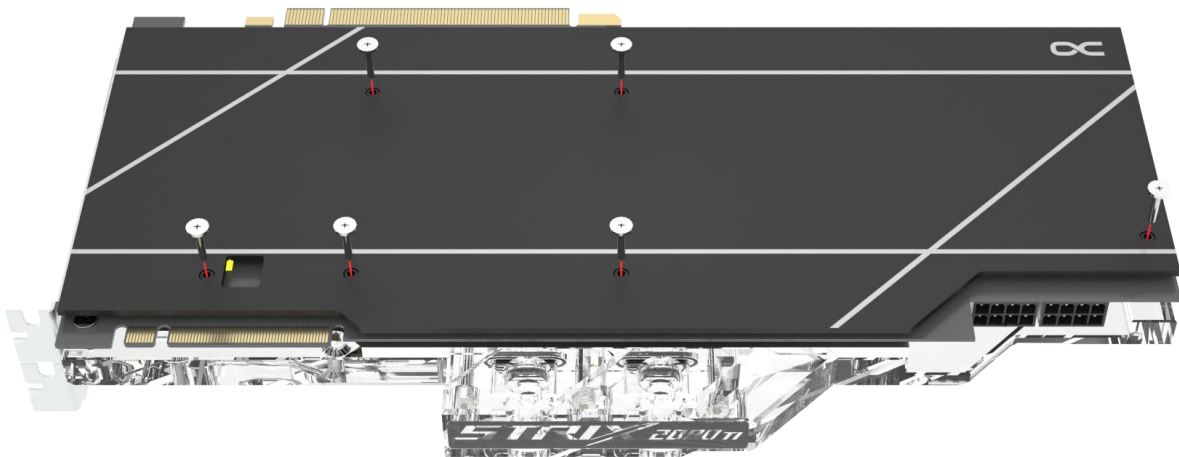

EN

Put the backplate on and screw it together with the 6 M2x1 | screws as shown.

DE

Legen Sie nun die Backplate auf und verschrauben Sie diese mit den 6 M2x1 | Schrauben wie dargestellt.

FR

Remettez maintenant la plaque arrière en place et vissez-la avec les 6 vis M2x1 | comme indiqué sur l'illustration.