

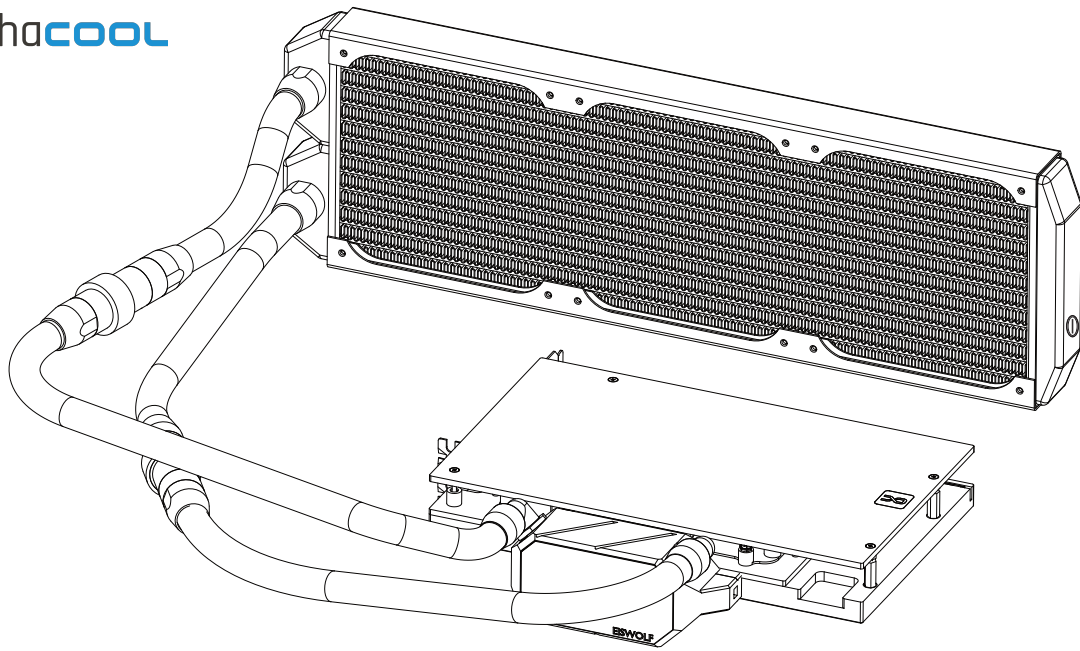

alphacool



Alphacool
Eiswolf 2



Safety instructions
Sicherheitshinweise
Avis de sécurité



Digital guide
Digitale Anleitung
Guide digital



EN

Accessories

DE

Zubehör

FR

Accessoires

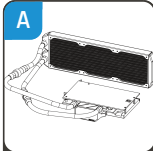

1x
Eiswolf 2
GPU AiO

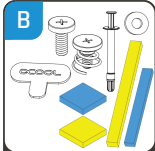

1x
Montage Set
GPU Cooler

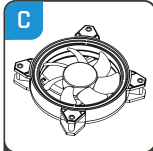

3x
120mm
Fan



12x
M3x6mm
Screw

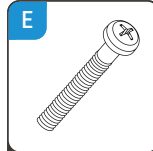

12x
M3x30mm
Screw

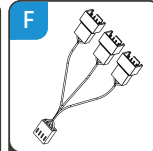

1x
PWM Cable
Y-Adapter

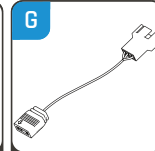

1x
ARGB
Adapter

EN

Mounting of the cooler

DE

Montage des Kühlers

FR

Montage du refroidisseur

Mount the cooler using the mounting kit (B) as described in the manual of the Aurora graphics card cooler instructions.

Montieren sie den Kühler mithilfe des Montage Sets (B) wie in der Anleitung des Aurora Grafikkartenkühlers beschrieben.

Montez le refroidisseur à l'aide du kit de montage (B) comme décrit dans le mode d'emploi du refroidisseur Aurora.

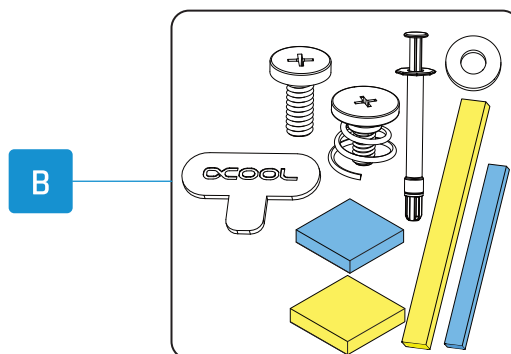

Mount fans pushing.

Lüfter drückend montieren.

Monter les ventilateurs poussent.

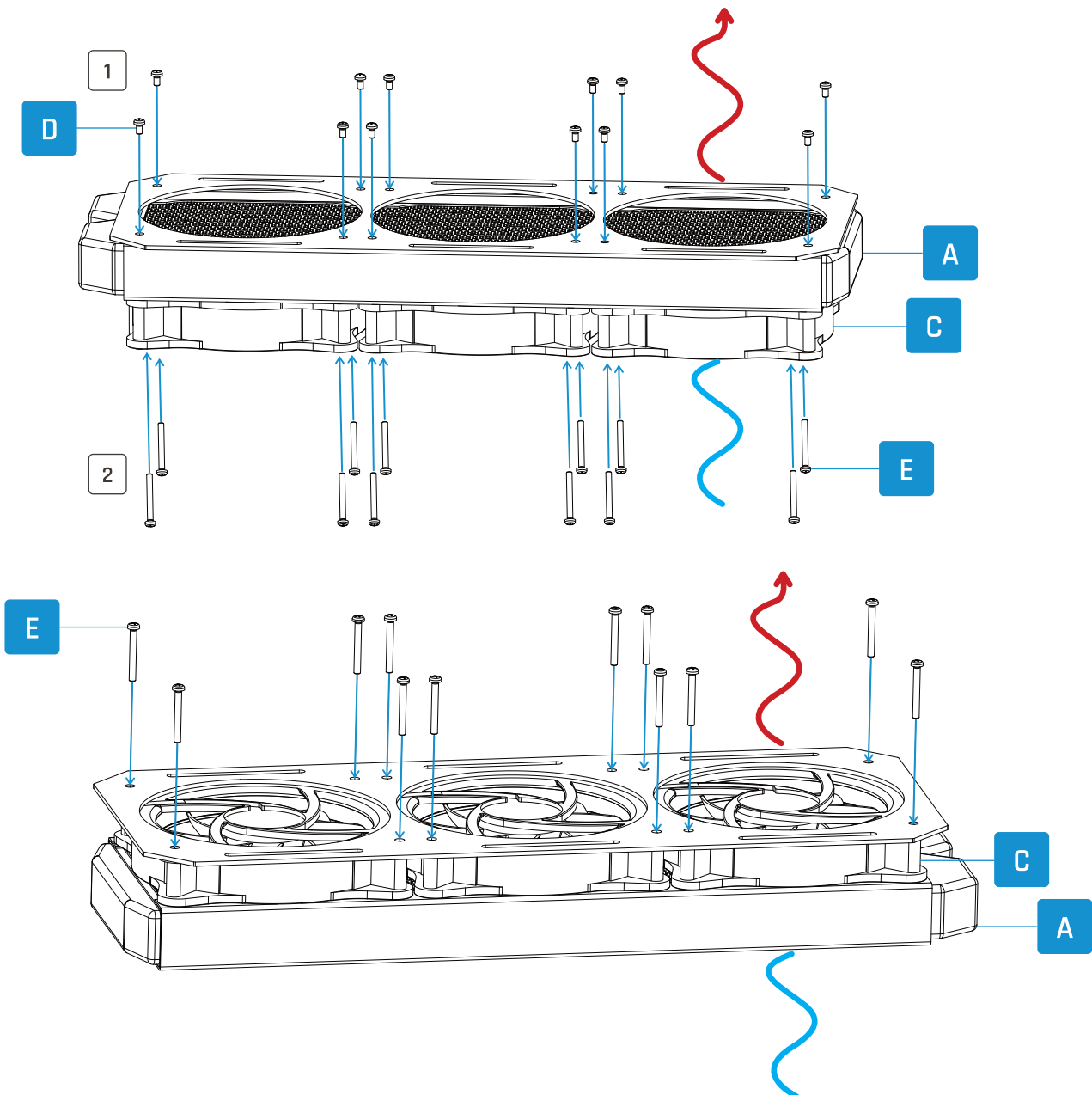

Mount fans pulling.

Lüfter saugend montieren.

Monter les ventilateurs à suction.

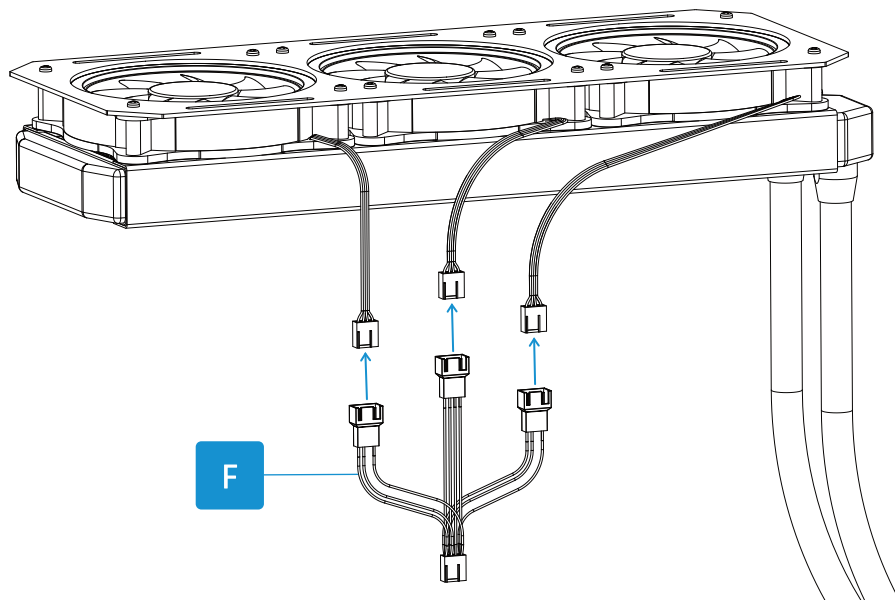

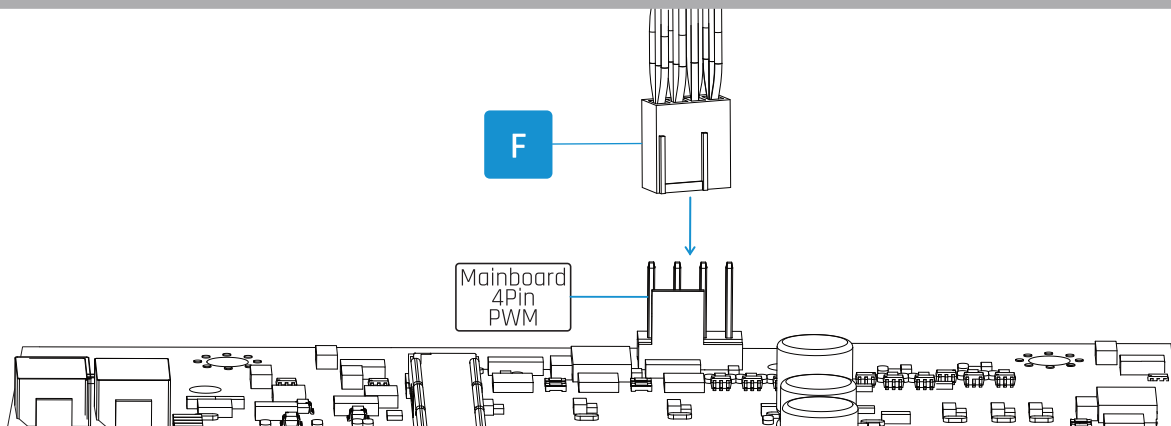

EN Three possibilities for the connection of the digital-RGB LED lighting

DE Drei Möglichkeiten für den Anschluss der digital-RGB LED Beleuchtung

FR Trois possibilités pour connecter l'éclairage LED RGB numérique

The digital RGB LEDs do not require more than 5V supply voltage.

Die Digital-RGB LEDs benötigen nicht mehr als 5V Versorgungsspannung.

L'éclairage LED RGB numérique ne nécessitent pas plus de 5V de tension d'alimentation.

Eiscontrol is not included in the accessories.

Eiscontrol ist nicht im Zubehör enthalten.

Eiscontrol n'est pas inclus dans les accessoires.

1

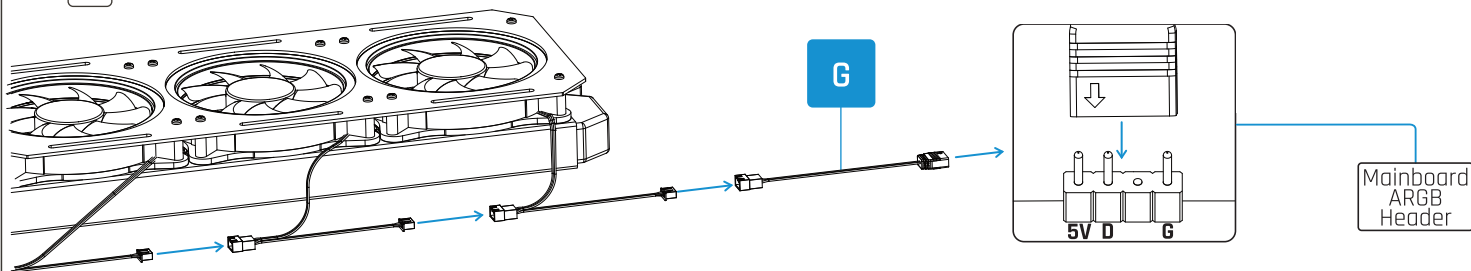

2

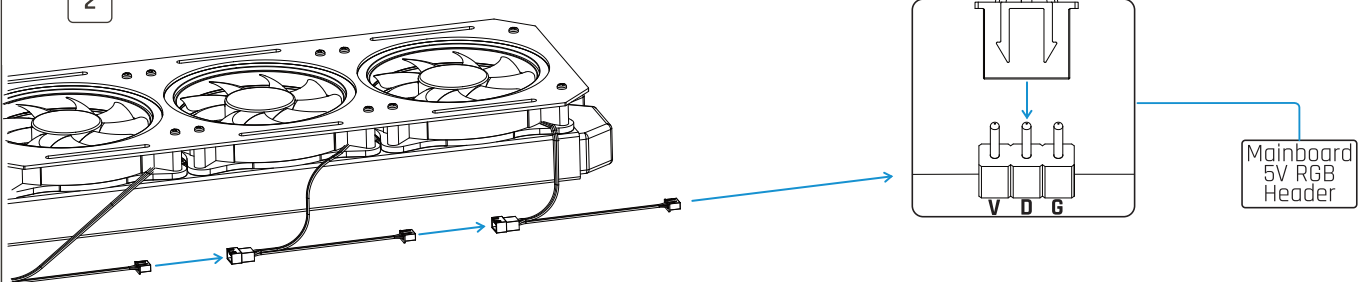

3

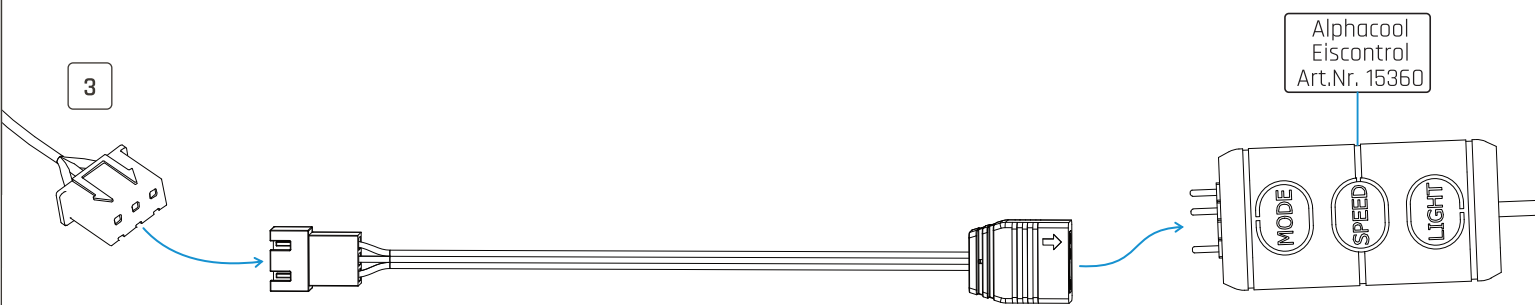

Make sure that the voltage is set to 12V in the bios. This is not necessary for PWM connections.

Hierbei muss im Bios die Spannung auf 12V gesetzt werden. Bei PWM Anschlüssen ist dies nicht notwendig.

Assurez-vous que la tension est réglée sur 12V dans le bios. Ceci n'est pas nécessaire pour les connexions PWM.

A

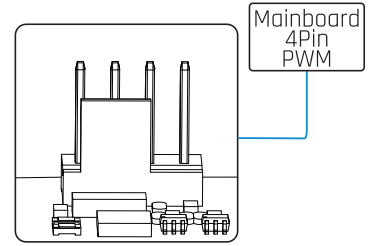
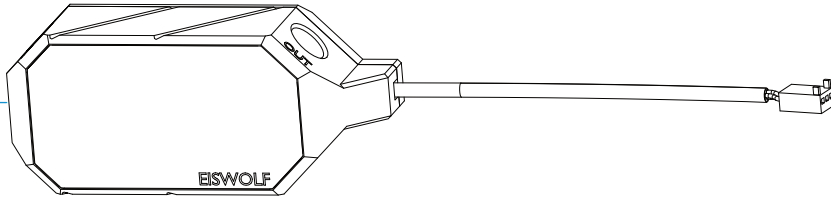

One or two drops of coolant may leak out.

Hierbei können ein bis zwei Tropfen Kühlflüssigkeit austreten.

Une ou deux gouttes de liquide de refroidissement peuvent s'écouler.

Open

Close

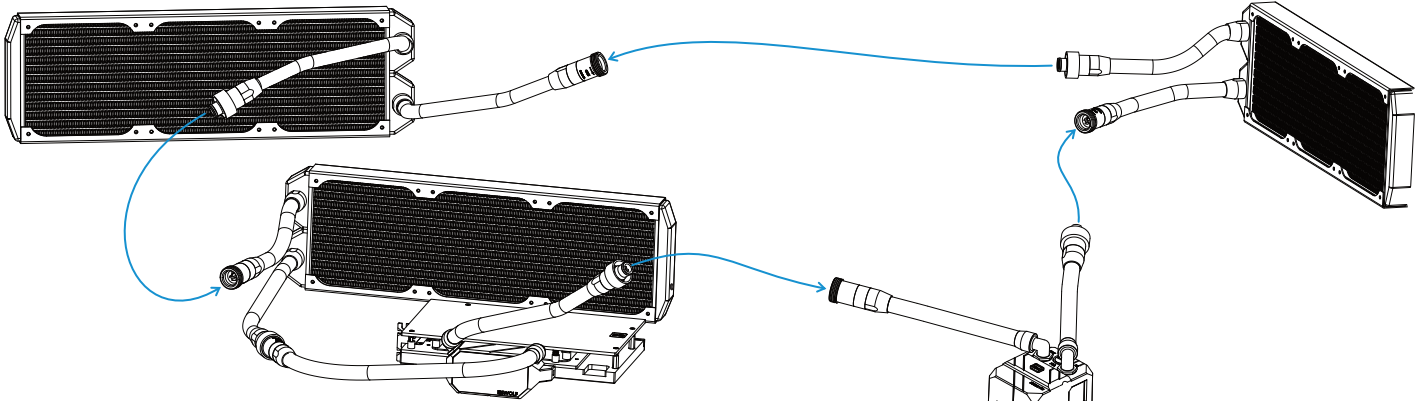
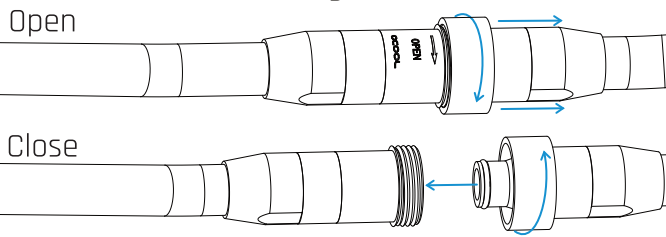

Need help?



Alphacool International GmbH
Marienberger Str. 1
D-38122 Braunschweig
Germany

Support: +49 (0) 531 28874-0
Fax: +49 (0) 531 28874 - 22
E-Mail: info@alphacool.com
<https://www.alphacool.com>

We care!