

Alphacool  
EISBLOCK AURORA ACRYL GPX-N RTX 4090 SUPRIM





Safety instructions  
Sicherheitshinweise  
Avis de sécurité













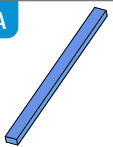
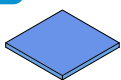
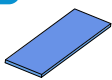
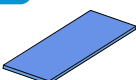

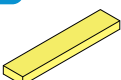

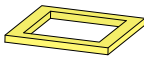
Digital guide  
Digitale Anleitung  
Guide digital



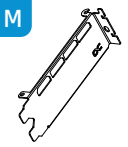

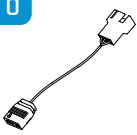
EN Accessories DE Zubehör FR Accessoires

- |  |   |   |   |   |   |   |   |  |
|--|---|---|---|---|---|---|---|--|
| <p><b>A</b></p>  <p>2x<br/>105x8x1mm<br/>Pad</p> | <p><b>B</b></p>  <p>1x<br/>15x15x1mm<br/>Pad</p> | <p><b>C</b></p>  <p>1x<br/>40x15x1mm<br/>Pad</p> | <p><b>D</b></p>  <p>2x<br/>51x15x1mm<br/>Pad</p> | <p><b>E</b></p>  <p>4x<br/>8x8x1mm<br/>Pad</p> | <p><b>F</b></p>  <p>2x<br/>51x8x3mm<br/>Pad</p> | <p><b>G</b></p>  <p>1x<br/>40x8x3mm<br/>Pad</p>      | <p><b>H</b></p>  <p>1x<br/>45x45x3mm<br/>GPU-Pad</p> | <p><b>I</b></p>  <p>1x<br/>Thermal grease</p> |
| <p><b>J</b></p>  <p>1x<br/>Putty tool</p>        | <p><b>K</b></p>  <p>9x<br/>M2x5 Screw</p>        | <p><b>L</b></p>  <p>9x<br/>EVA washer</p>        | <p><b>M</b></p>  <p>1x<br/>PCI Bracket</p>       | <p><b>N</b></p>  <p>8x<br/>M2x11 Screw</p>     | <p><b>O</b></p>  <p>1x<br/>ARGB Adaptor</p>     | <p><b>P</b></p>  <p>2x<br/>G1/4" Plugs</p> | <p><b>Q</b></p>  <p>1x<br/>Plug tool</p>             |  |

EN

Check compatibility

DE

Kompatibilität prüfen

FR

Vérification de compatibilité

Before starting the cooler assembly, compare your card with the pictures in our configurator. To do so, visit <https://www.hwconfig.com> and search for your graphics card or cooler model. For a definitive identification, you can also compare the PCB number. The cooler was designed for a special PCB layout. Occasionally, graphics card manufacturers may revise the design of their card slightly, causing the cooler not to fit on later models. During assembly, please make sure taller parts have enough space around them and that the cooler does not damage your graphics card.

Alphacool International GmbH is not liable for assembly errors occurring due to negligence, such as selecting an incompatible cooler.

Bevor Sie mit der Montage des Kühlers beginnen, vergleichen Sie Ihre Platine mit den Fotos in unserem Konfigurator. Besuchen Sie dafür <https://www.hwconfig.com> und suchen Sie nach Ihrem Grafikkarten- oder Kühlermodell. Zur eindeutigen Zuordnung kann dort auch die PCB Nummer verglichen werden. Der Kühler wurde für ein spezielles PCB Layout konstruiert. Es kommt vor, dass Grafikkartenhersteller über Revisionen den Aufbau leicht abändern und der Kühler auf spätere Modelle nicht mehr passt. Achten Sie auch bei der Montage darauf, dass hohe Bauteile frei liegen und der Kühler die Grafikkarte nicht beschädigt.

Alphacool International GmbH haftet nicht bei fahrlässigen Montagefehlern, wie die Wahl eines inkompatiblen Kühlers.

Avant de commencer l'assemblage du refroidisseur comparez votre carte avec les images de notre configurateur. Pour ce faire, visitez <https://www.hwconfig.com> et cherchez votre carte graphique ou votre modèle de refroidisseur. Pour une identification précise, vous pouvez également comparer le numéro de la PCB. Le refroidisseur a été conçu pour une disposition spéciale du PCB. Il est possible que le fabricant change des détails dans la disposition de ses composants lors d'une révision et que le bloc de refroidissement ne soit plus compatible. Veillez lors de l'installation au fait que les composants hauts ne touchent pas le bloc de refroidissement et que le bloc n'endommage pas la carte graphique.

Alphacool International GmbH n'est pas responsable ni des erreurs d'installation ni du choix d'un refroidisseur incompatible.

EN

Prepare graphics card

DE

Grafikkarte vorbereiten

FR

Préparer la carte graphique

Put the hardware on an antistatic mat. Begin dismantling the original cooler. Depending on the structure of the cooler, remove the screws at the back of the card and carefully unhook the fan connector first. If the original cooler uses thermal glue, extreme care should be taken as you can easily damage parts. Pick up all the items carefully. Next, clean the hardware of thermal paste or pad residues with a solvent (e.g. isopropanol alcohol).

Legen Sie die Hardware auf eine antistatische Unterlage. Beginnen Sie mit der Demontage des Original-Kühlers. Je nach Aufbau des Kühlers sind zuerst die Schrauben des Lüfters zu entfernen und die Blenden zu lösen. Bei aufgeklebten Kühlern ist äußerste Sorgfalt geboten. Es können leicht Bauteile abgerissen werden. Heben Sie alle Einzelteile sorgfältig auf. Reinigen Sie anschließend die Hardware von Resten der Wärmeleitpaste oder Pads mit einem Lösemittel (z.B. Isopropanol-Alkohol).

Posez le matériel sur un tapis antistatique. Commencez par le démontage du refroidisseur d'origine. Selon la configuration du radiateur les vis du ventilateur et les caches doivent être enlevés d'abord. S'il s'agit d'un refroidisseur collé il faut travailler très doucement. Sinon des composants peuvent s'arracher. Conservez tous les pièces soigneusement. Ensuite, nettoyez le matériel de résidus de la pâte thermique ou de pads avec un solvant (alcool isopropanol par ex.).

EN

Place thermal pads on cooling block

DE

Wärmeleitpads auf dem Kühlblock platzieren

FR

Placer les pads thermique sur le bloc

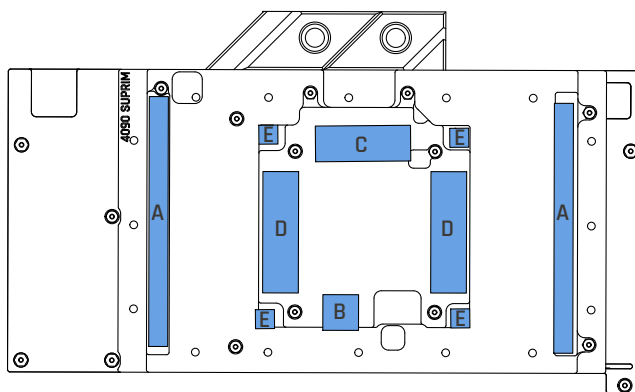

EN

Apply Thermal Grease

DE

Wärmeleitpaste auftragen

FR

Appliquer la pâte thermique

1

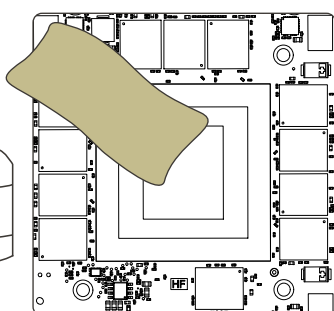

2

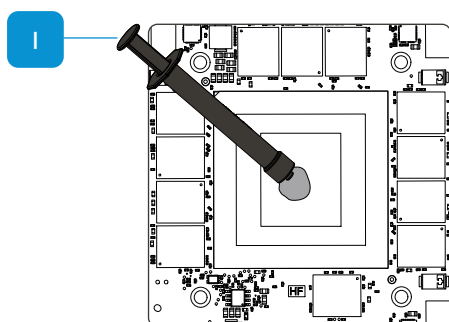

3

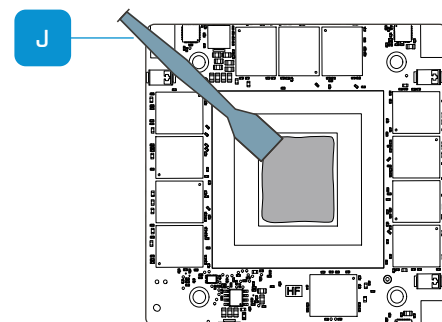

EN

Install PCB

DE

Installiere PCB

FR

Installer PCB

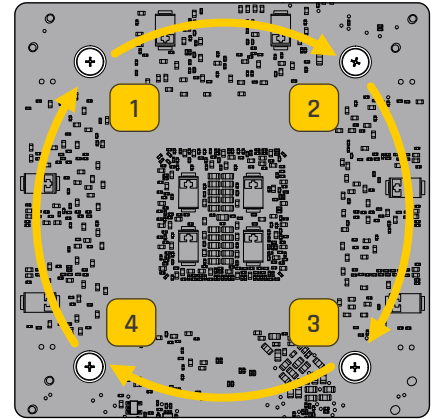
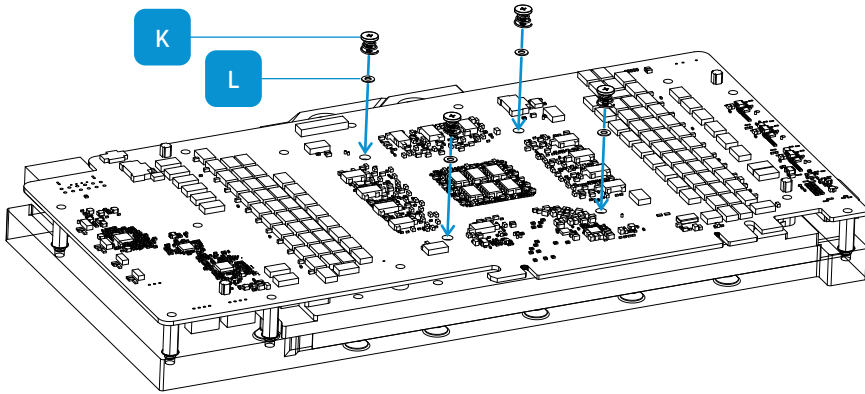

EN

Install PCB

DE

Installiere PCB

FR

Installer PCB

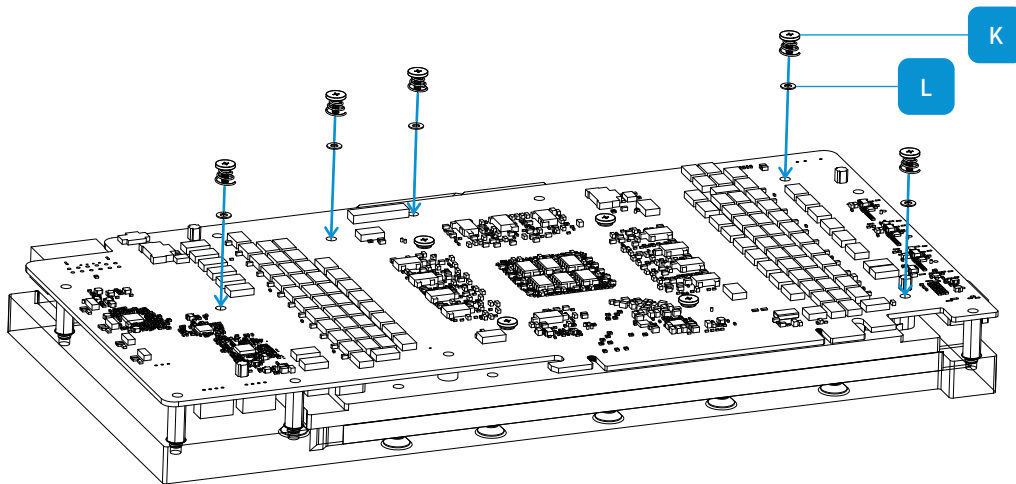

EN

Place thermal pads on PCB backside

DE

Wärmeleitpads auf der PCB Rückseite platzieren

FR

Placer les pads thermique sur le PCB au dos

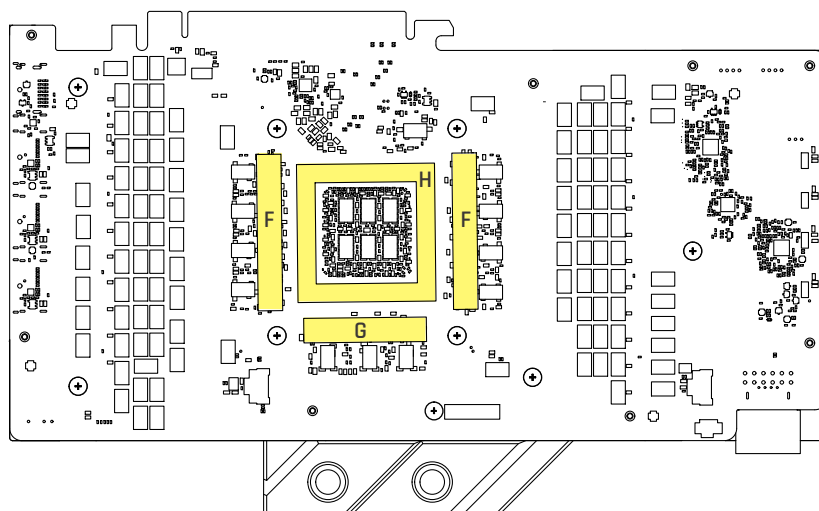

EN Mount backplate and PCI Bracket

DE Backplate und PCI Slotblende montieren

FR Monter la plaque arrière et le couvercle PCI

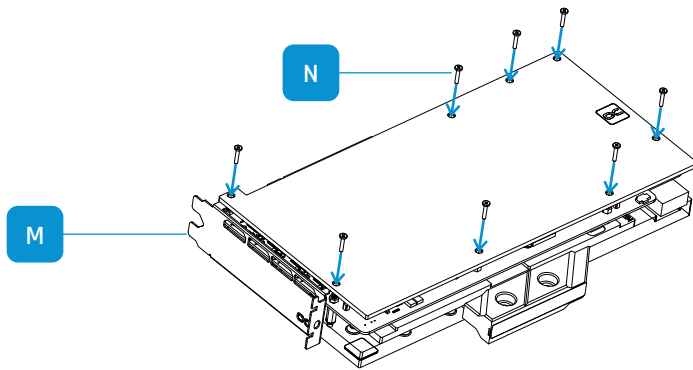

EN Connect ARGB lighting

DE ARGB Beleuchtung anschließen

FR Connecter l'éclairage ARGB

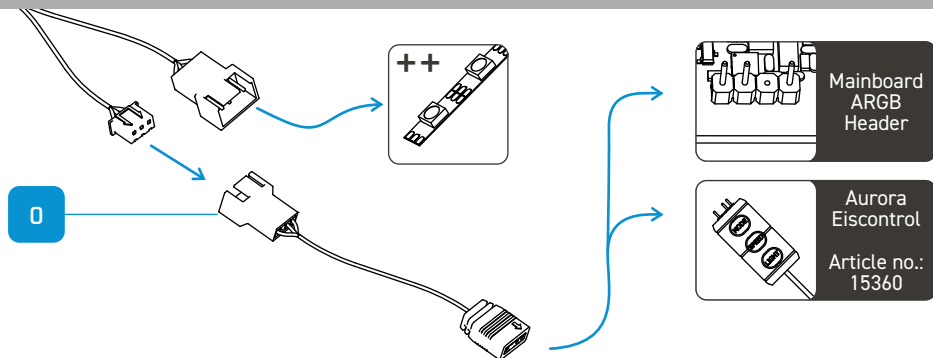

EN Screw in screw plugs with the tool

DE Verschlusschrauben eindrehen

FR Visser les vis de fermeture avec l'outil

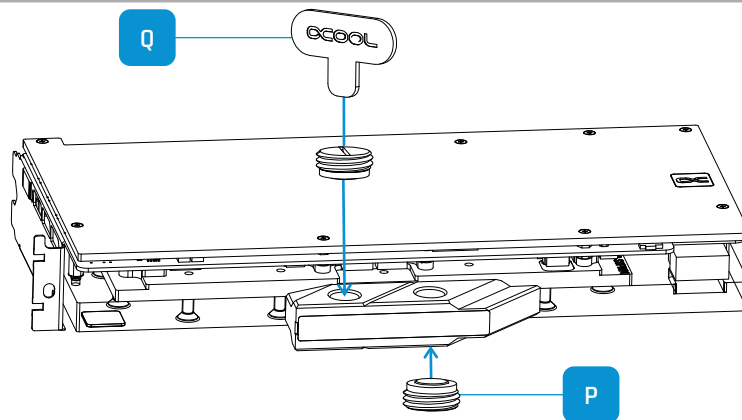

Need help?



AlphaCool International GmbH  
 Marienberger Str. 1  
 D-38122 Braunschweig  
 Germany

Support: +49 (0) 531 28874 - 0  
 Fax: +49 (0) 531 28874 - 22  
 E-mail: [info@alphacool.com](mailto:info@alphacool.com)  
<https://www.alphacool.com>

We care!